

Resusci Anne Modular System Cat. Nos. 31 00 0x, 31 00 1x, 31 00 3x, 31 00 4x

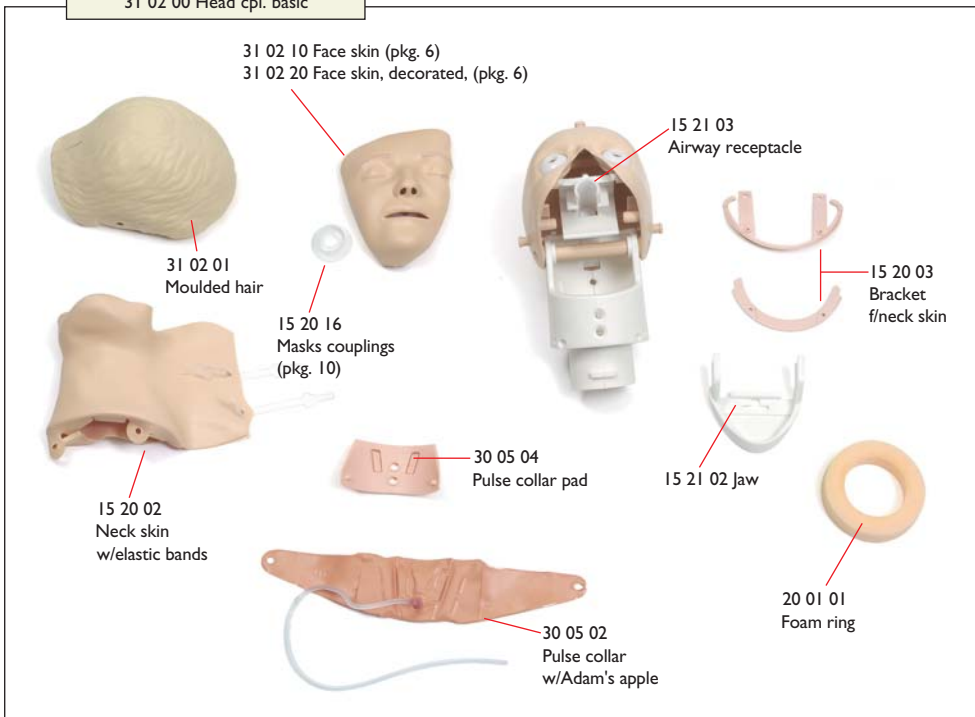

31 02 00 Head cpl. basic



NOT ILLUSTRATED

- 04 20 00 Carrying case Torso
- 18 39 10 CPR training mat
- 31 15 00 Directions for use
- 31 15 90 Technical manual
- 15 20 07 Paper bags f/face skin (pkg. 1000)
- 15 39 04 SkillGuide board RA



15 38 00 Side connection unit (SkillGuide manikin)



15 39 00 SkillGuide cpl.

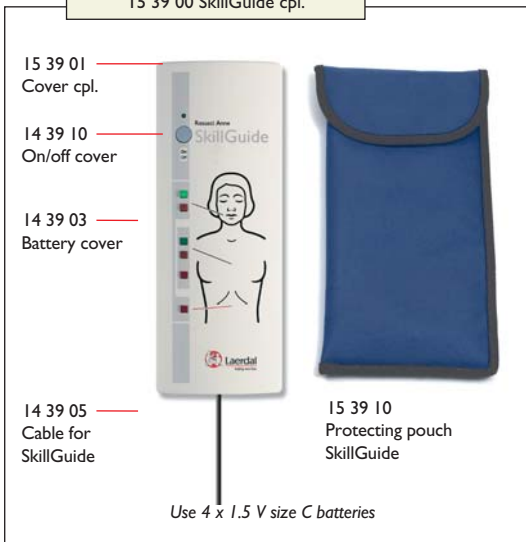

11 06 05 Blind plate



15 36 20 Cable f/hand position circuit board

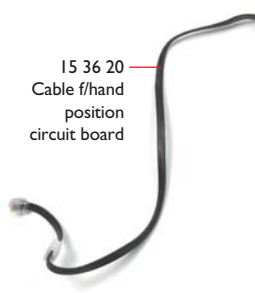

15 36 10 Circuit board f/hand position unit

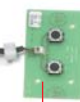

Resusci Anne Modular System Cat. Nos. 31 00 2x, 31 00 5x

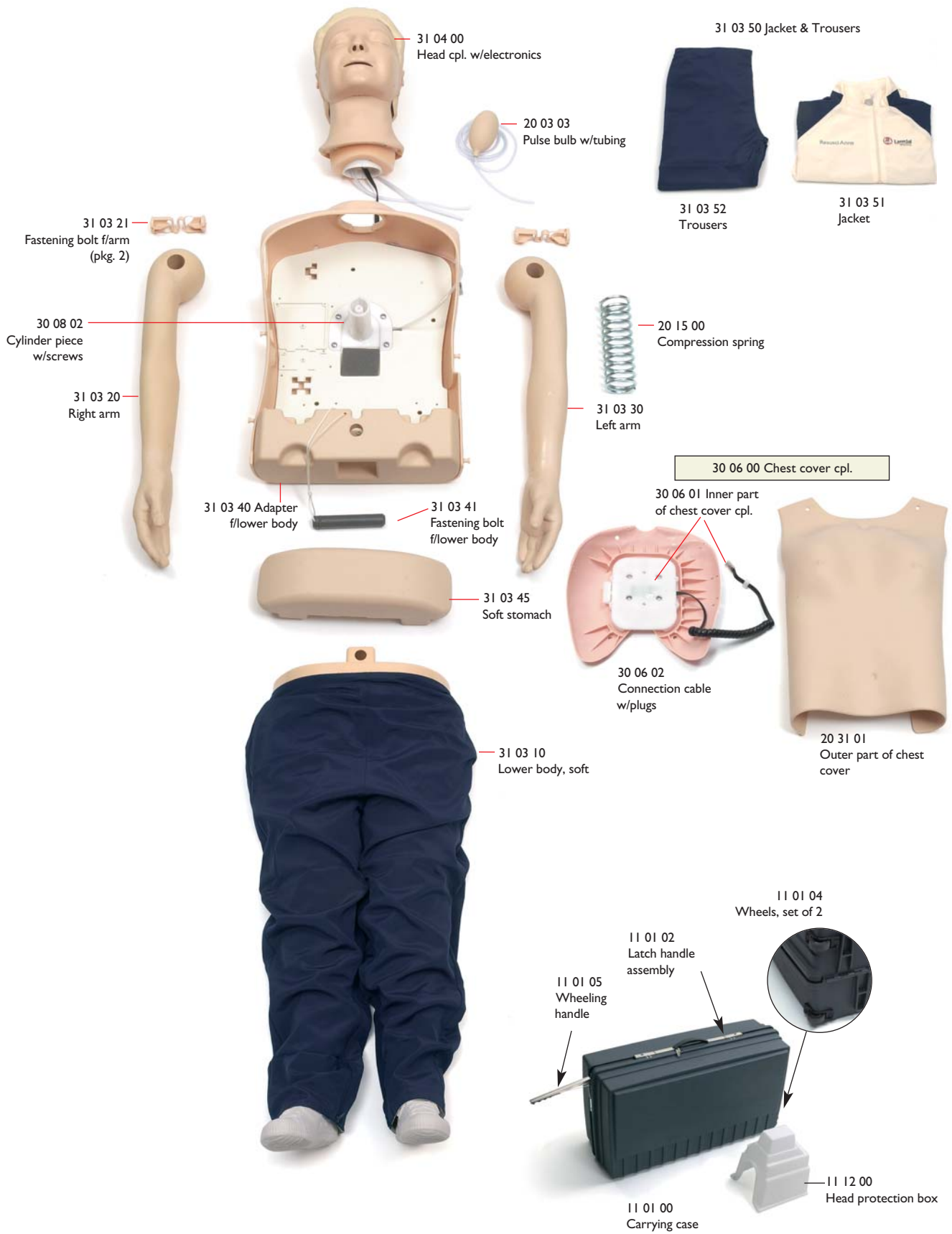

31 04 00 Head cpl. w/electronics

NOT ILLUSTRATED

- 04 20 00 Carrying case Torso
- 18 39 10 CPR training mat
- 31 15 00 Directions for use
- 31 15 90 Technical manual
- 15 20 07 Paper bags f/face skin (pkg. 1000)

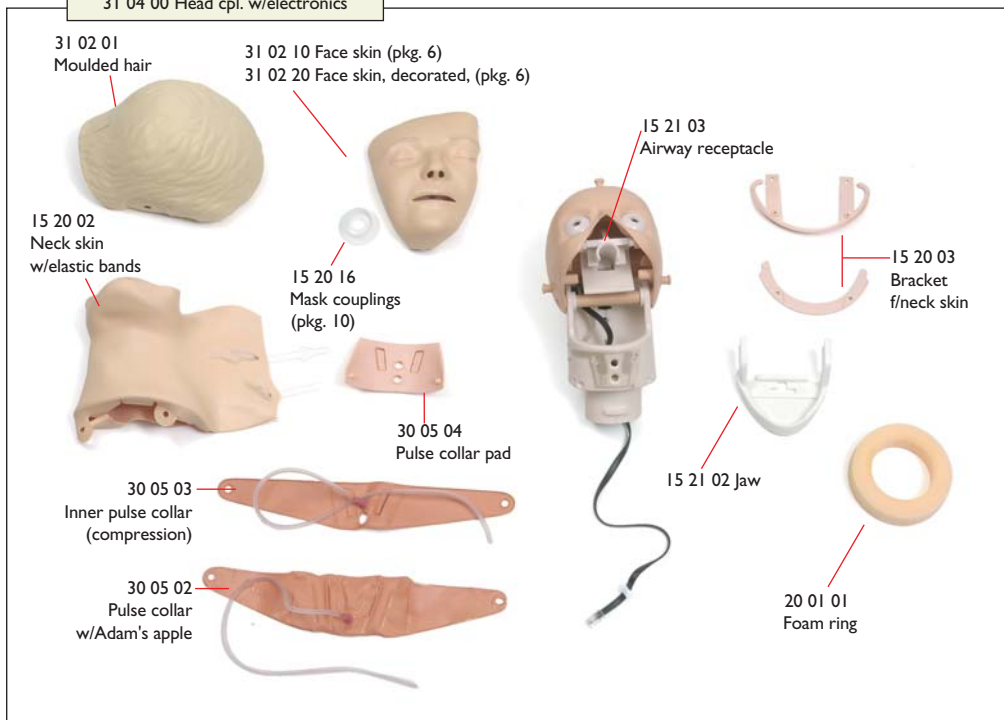

31 50 00 SkillReporter cpl.

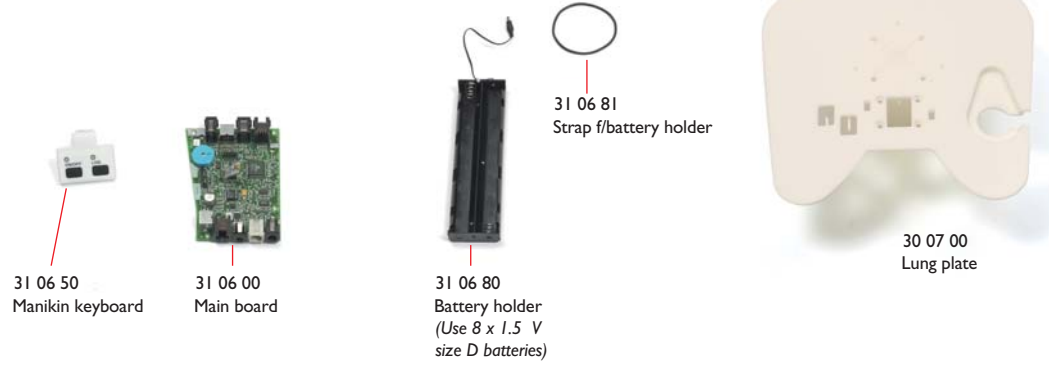

Resusci Anne Modular System Cat. Nos. 32 00 2x, 32 00 5x

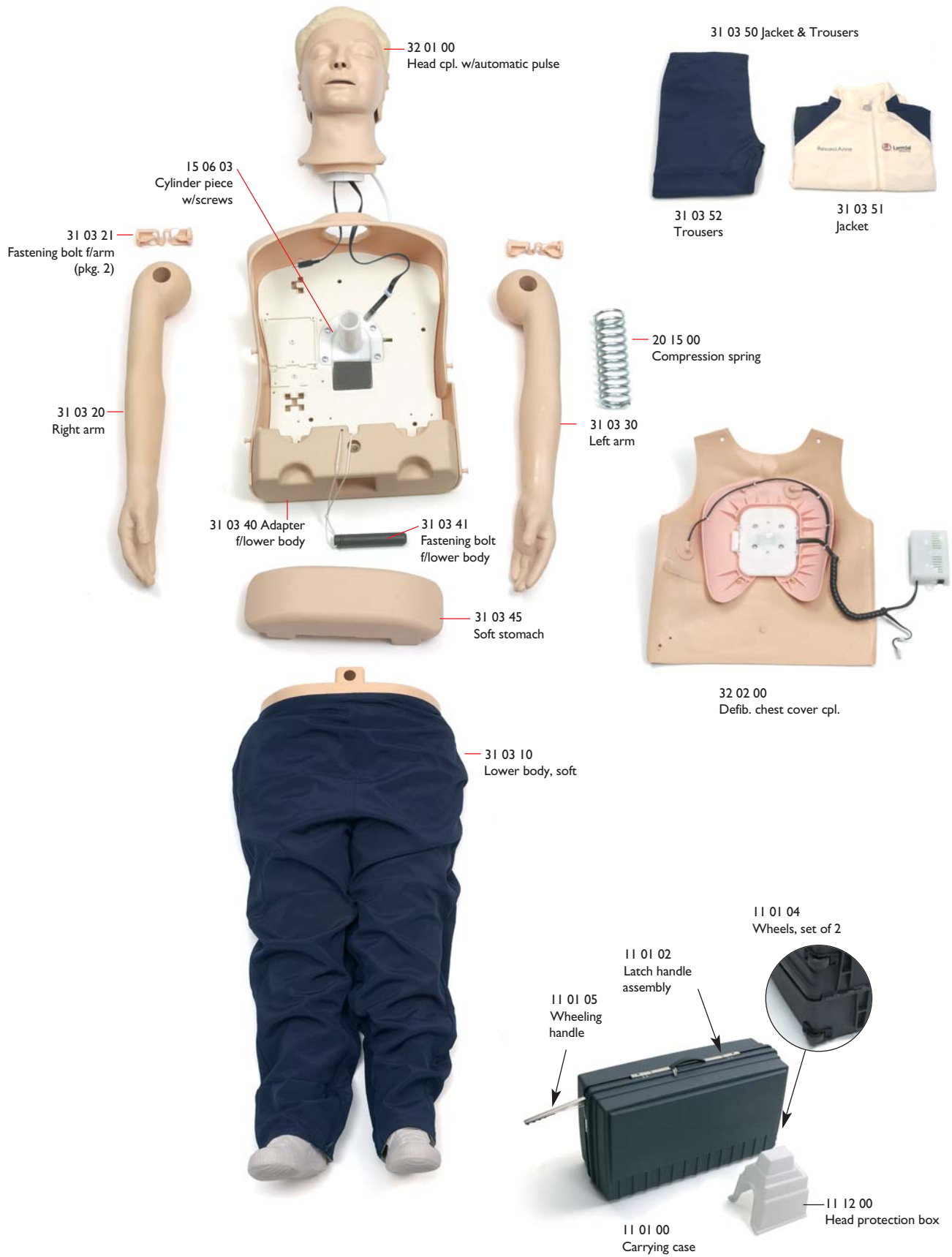

32 01 00 Head cpl. w/automatic pulse

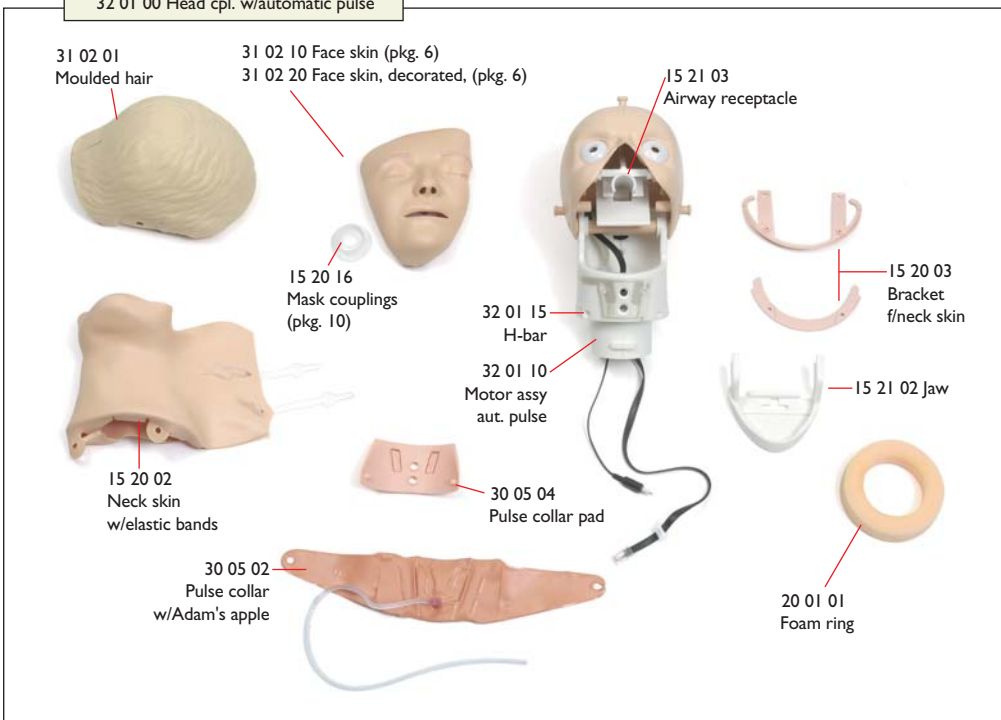

NOT ILLUSTRATED

- 04 20 00 Carrying case Torso
- 18 39 10 CPR training mat
- 31 15 00 Directions for use
- 31 15 90 Technical manual
- 15 20 07 Paper bags f/face skin (pkg. 1000)
- 32 02 56 Power resistor 150R 50W
- 94 50 04 Cable FR2 - Manikin
- 29 12 07 Cable main board - loadbox
- 32 10 40 Manikin defib adapter Cable

31 50 00 SkillReporter cpl.



32 50 00 MicroHeartsim cpl.



31 06 80 Battery holder (Use 8 x 1.5 V size D batteries)

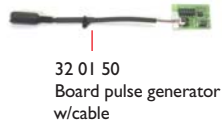
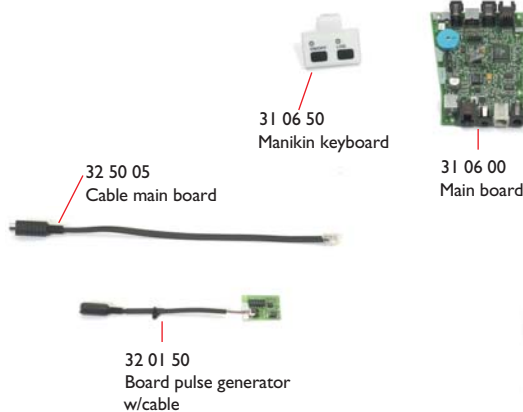

Resusci Anne Modular System Cat. Nos. 32 00 60, 32 00 80



31 02 00 Head cpl. basic

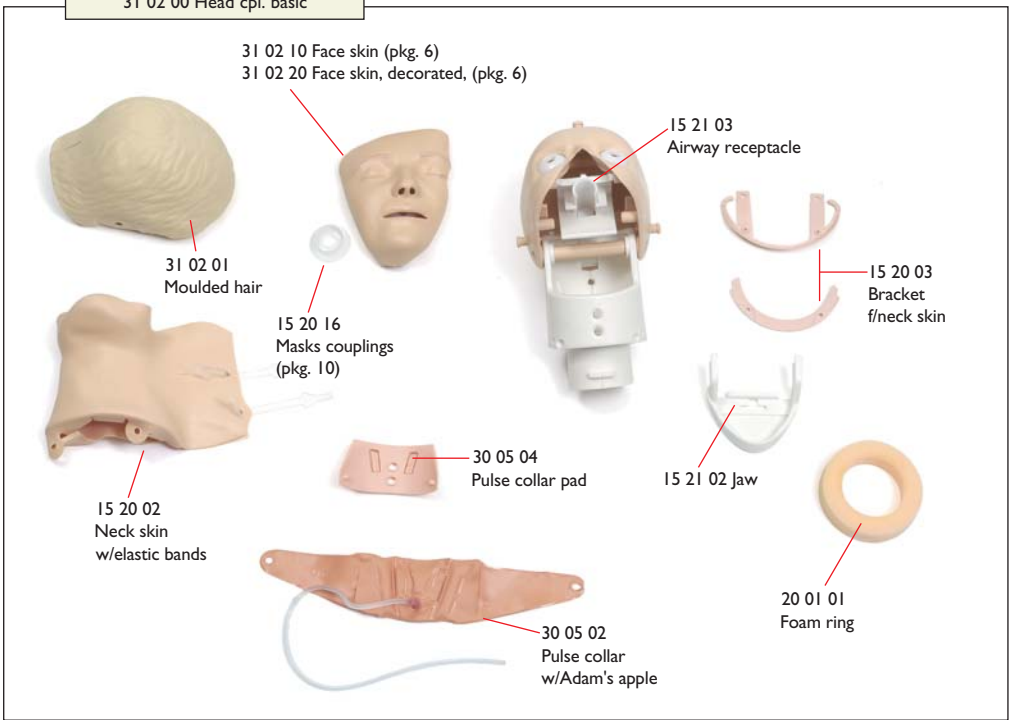

NOT ILLUSTRATED

- 04 20 00 Carrying case Torso
- 18 39 10 CPR training mat
- 31 15 00 Directions for use
- 31 15 90 Technical manual
- 15 20 07 Paper bags f/face skin (pkg. 1000)
- 15 39 04 SkillGuide board RA

15 39 00 SkillGuide cpl.

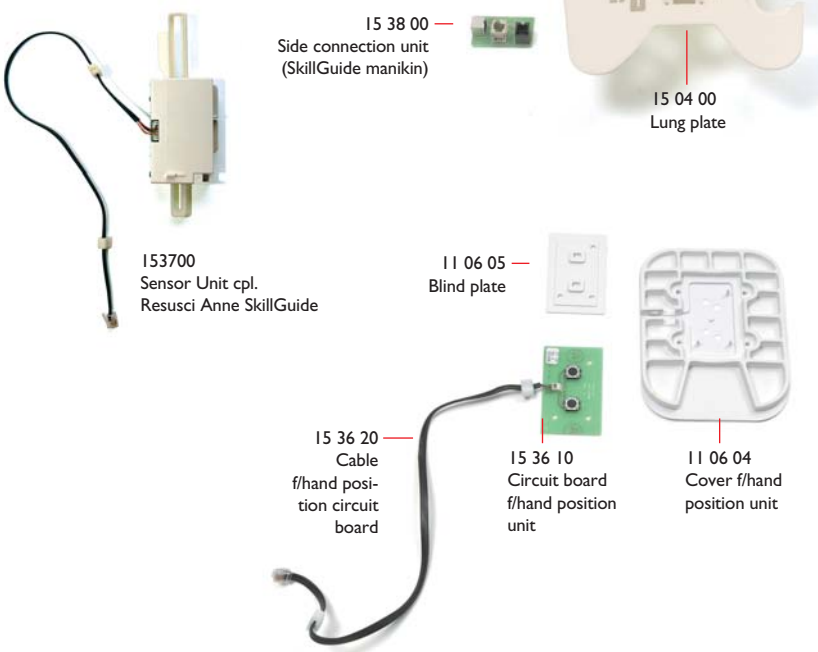
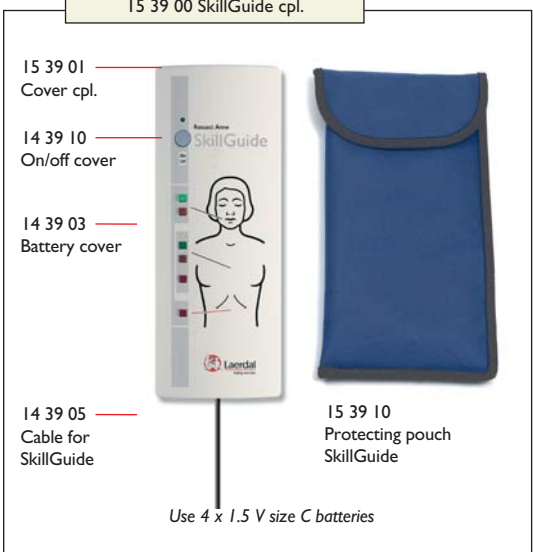

NOT ILLUSTRATED

- 94 50 21 Label status AED Trainer 2 (pkg. 10)
- 94 50 25 Board AED Trainer 2
- 94 50 26 Speaker with cable
- 94 50 27 Cable AED Trainer 2
- 94 50 55 Programming kit for AED Trainer 2 (optional software and cable)
- 94 50 60 Technical manual

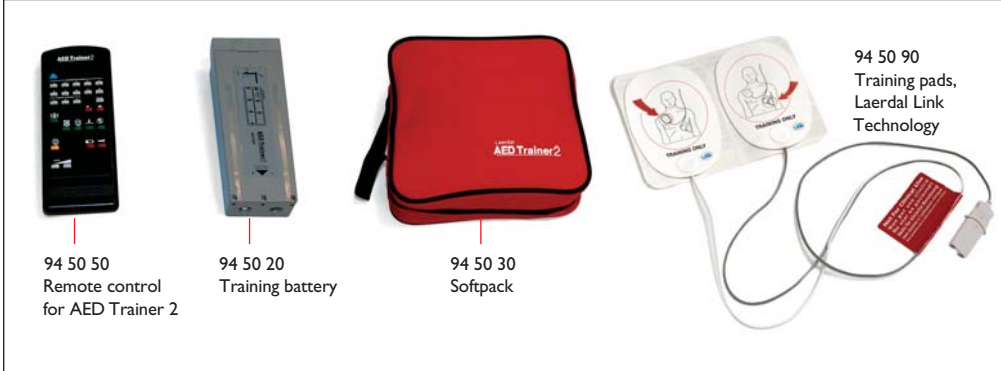

Resusci Anne Modular System Cat. Nos. 32 00 70, 32 00 90



31 04 00 Head cpl. w/electronics

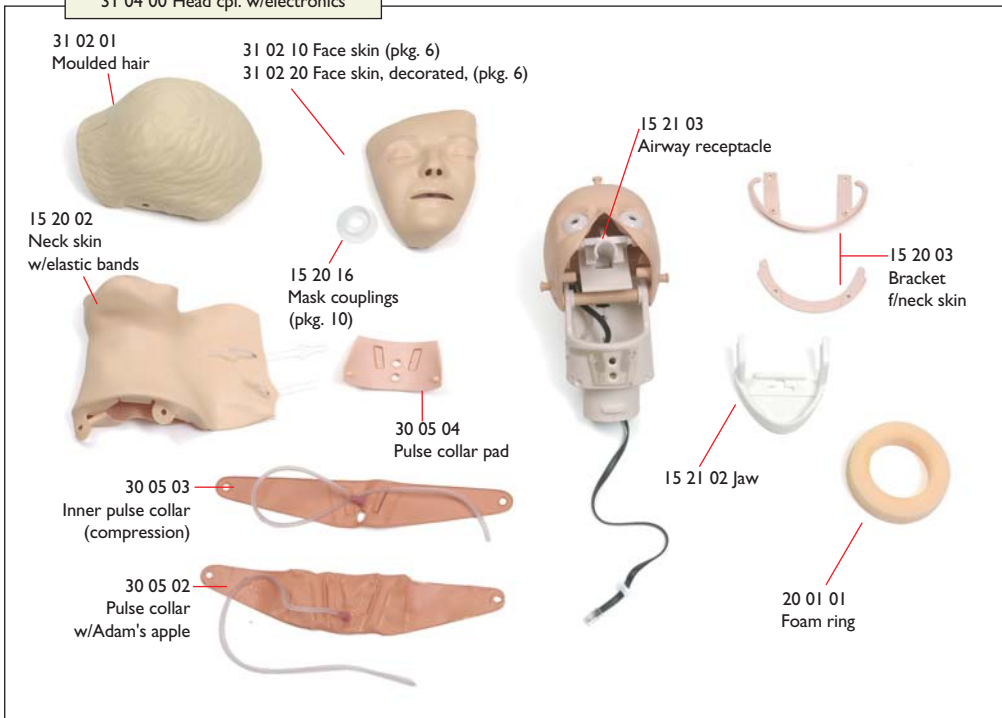

NOT ILLUSTRATED

- 04 20 00 Carrying case Torso
- 18 39 10 CPR training mat
- 31 15 00 Directions for use
- 31 15 90 Technical manual
- 15 20 07 Paper bags f/face skin (pkg. 1000)

31 50 00 SkillReporter cpl.



31 06 81 Strap f/battery holder



31 06 80 Battery holder (Use 8 x 1.5 V size D batteries)

31 05 00 Sensor unit cpl.



31 06 50 Manikin keyboard



31 06 00 Main board



94 50 50 Remote control for AED Trainer 2



94 50 20 Training battery



94 50 30 Softpack



94 50 90 Training pads, Laerdal Link Technology

NOT ILLUSTRATED

- 94 50 21 Label status AED Trainer 2 (pkg. 10)
- 94 50 25 Board AED Trainer 2
- 94 50 26 Speaker with cable
- 94 50 27 Cable AED Trainer 2
- 94 50 55 Programming kit for AED Trainer 2 (optional software and cable)
- 94 50 60 Technical manual

Resusci Anne Modular System

The Resusci Anne Modular System allows you to tailor make your manikin to meet the diversity of training needs, from the simplest CPR Torso to the full body / full featured CPR-D and First Aid versions.

Each Torso model can be equipped with various types of arms and legs.



Arms with soft legs



31 03 00

Rescue module



31 20 00

First Aid/Trauma module

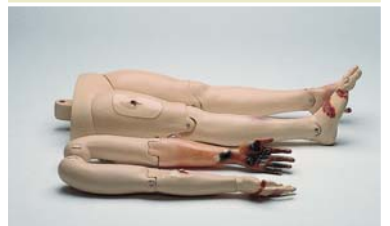

31 20 50

Bleeding control leg



09 00 50

IV arm



31 20 25



Simple arm and leg attachments allow you to build the manikin of your choice within seconds. No tools are required.

Update kits Resuci Anne Modular System

Update your Resuci Anne Basic to SkillGuide Resuci Anne

15 40 00 SkillGuide update kit

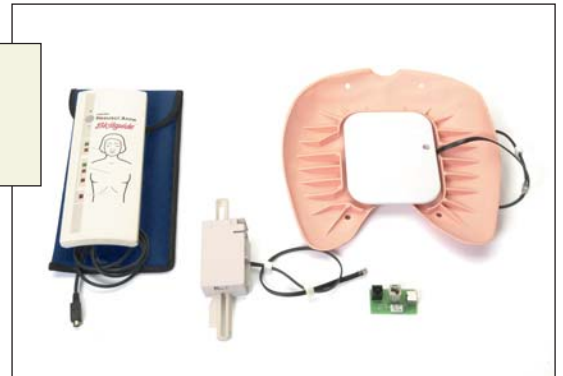

Update your Resuci Anne Basic or SkillGuide to SkillReporter Resuci Anne

31 10 00 SkillReporter update kit



Update your Resuci Anne Basic or SkillGuide to CPR-D Resuci Anne

32 10 00 Defib. update kit Basic/SkillGuide



Update your SkillReporter Resuci Anne to CPR-D Resuci Anne

32 10 10 Defib. update kit SkillReporter

